

8RV

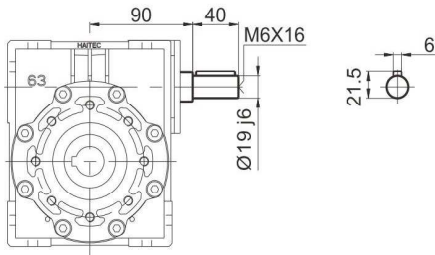

8RV.VS

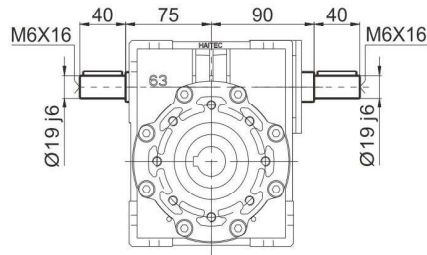

Output shaft
输出轴

AB

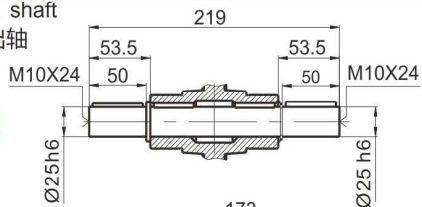

AS右

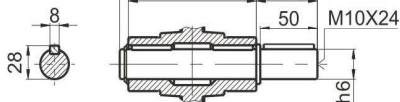

AS左

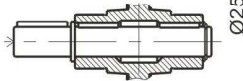

Output flange
输出法兰

FE

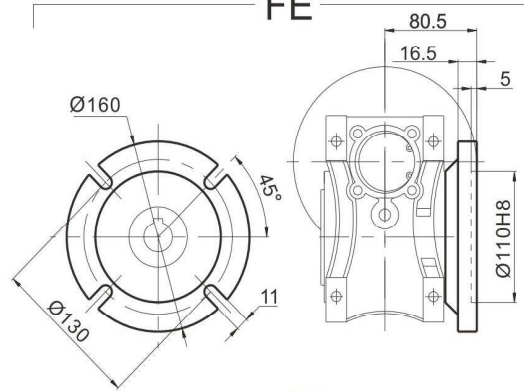

FA

FB

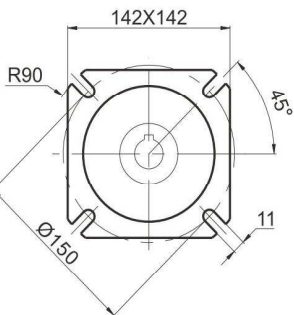

FC

FD

